

# HOW TO MEASURE A FAN

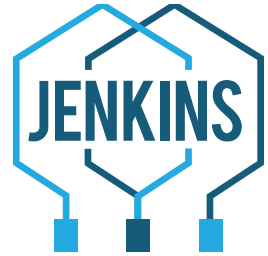

## SERIES 7 FAN DIMENSIONS:

- A= BLADE HEIGHT
- B= HUB DIAMETER
- C= HUB THICKNESS
- D= OVERALL DIAMETER
- E= HUB RECESS
- H= PLATE DIAMETER
- NO. OF BLADES
- NO. OF SET SCREWS

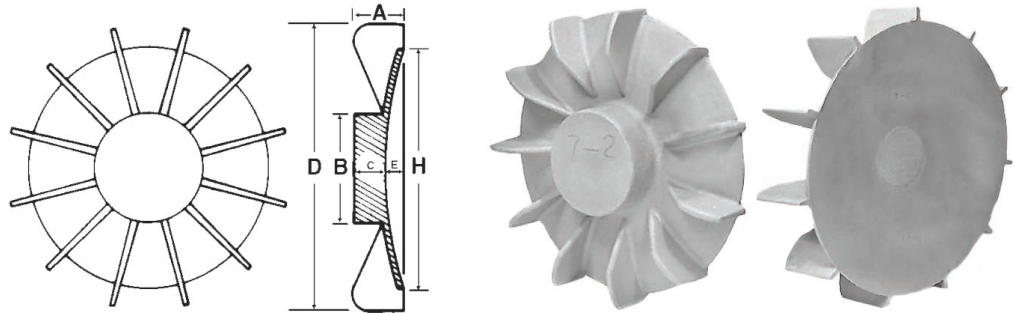

**DIMENSIONS** Overall diameter (D) is most critical in determining air delivery over the motor. Blade width or height (A) is also important, but the number of blades is not significant. Be sure the fan blade you choose clears the bearing housing outside diameter, and the fan cover inside diameter. Tolerances are  $\pm 1/8$ " on all dimensions except bore.

**BORE** We will bore any of our aluminum fans to  $\pm 0.001$ " tolerance (straight bore only). We recommend that you order your fan to the same micrometer measurement as the motor shaft journal. Please specify the keyway size if desired. We do not recommend split hubs in aluminum fans. The split concentrates the stress on the fan back plate and will encourage cracking failure unless the bore of the fan is within a few thousandths of the shaft size.

A "Maximum Allowed Bore" is shown for each blank bore fan, except Series 11. Large bores may weaken the hub, particularly if a keyway is required. Our machining department meets the Calibration System Requirements in MIL-STD-45662A.

**FRAME** The frame shown is for 1200 and 1800 RPM motors except those marked "TS" which are 3600 RPM motors. Fans shown for "T" frames are safe for use with the same frame number in either "U" frames or old NEMA frames. They are also safe to use with older, higher-number fans as long as the rated horsepower is the same or less than the horsepower of the "T" frame listed.

**FAN COVERS** We currently stock Toshiba OEM fan covers, however, we can supply fan covers from a variety of manufacturers such as ABB, Baldor, General Electric, Leeson, Lincoln, Reliance, Siemens Energy, Teco-Westinghouse, US Electric, WEG and Worldwide Electric.

**SPECIAL FANS** We have many fans and patterns in stock which are not illustrated or listed. The best method of identification is to send in a sample fan for us to match (even if it is broken). If we do not have a pattern, we can make a metal or wooden pattern for complex shapes. You are charged for our net cost in obtaining the pattern, but we retain the pattern for future use. Our pattern making charge is estimated upon request.

**HOW TO INSTALL A FAN:** To install or remove the fan, warm it with a torch or in an oven, and slip it on the shaft.